

**WITH 5-YEAR WARRANTY**

# Owner's Manual

# Marlin®

## LEVER ACTION 22 RIFLES

(Shorts, Longs, Long Rifles)

### IMPORTANT

*This manual contains operating, care and maintenance instructions. To assure safe operation, any user of this firearm must read this manual carefully. Failure to follow the instructions and warnings in this manual can cause accidents resulting in injury or death. This manual should always accompany this firearm, and be transferred with it upon change of ownership.*

*The warranty card attached to the cover must be filled out and mailed within 10 days of purchase.*

**WARNING: KEEP THIS FIREARM OUT OF THE REACH OF CHILDREN, UNAUTHORIZED INDIVIDUALS, AND OTHERS UNFAMILIAR WITH THE SAFE HANDLING OF FIREARMS.**

### LIMITED WARRANTY AND CERTIFICATE OF OWNERSHIP

To insure warranty protection, this card must be completed and mailed within 10 days of purchase.

**Model** \_\_\_\_\_ **Date of Purchase** \_\_\_\_\_  
**Serial Number** \_\_\_\_\_

I have read the Owner's Manual  
and request registration of my warranty. \_\_\_\_\_  
(signature of owner)

Please Print

**Owner** \_\_\_\_\_ **Address** \_\_\_\_\_

**City** \_\_\_\_\_ **State** \_\_\_\_\_ **Zip Code** \_\_\_\_\_

**e-mail** \_\_\_\_\_

**Name of Store where purchased** \_\_\_\_\_ **City** \_\_\_\_\_ **State** \_\_\_\_\_

To help us provide new and better products we would appreciate your answers to the following questions.

**Your Occupation**

- Farm
- Student
- Office
- Industrial
- Professional
- Managerial

**Your Age Group**

- Under 18
- 18-24
- 25-34
- 35-49
- 50+

**Which of these influenced your purchase?**

- Previous experience with product
- Brand reputation
- Marlin web site
- Marlin advertisement
- Marlin catalog

**Was this product a gift?**

- Yes
- No



MFC  
P.O. Box 248  
North Haven, CT 06473-0903



## LIMITED WARRANTY

### The Marlin Firearms Company FIVE YEAR LIMITED WARRANTY AGAINST DEFECTS IN MATERIAL & WORKMANSHIP

This firearm warranty is good only to the ORIGINAL OWNER who has registered his ownership with The Marlin Firearms Company at 100 Kenna Drive, North Haven, Connecticut.

WARRANTY and CERTIFICATE OF OWNERSHIP card **must** be completed and mailed to The Marlin Firearms Company at the above address WITHIN TEN (10) DAYS of purchase to insure the protection of the warranty. NOTICE of defect in materials and/or workmanship **must** be received by the company WITHIN FIVE (5) YEARS from the date of purchase.

Normal wear, or damage resulting from neglect, abuse, alteration, or repairs not made or authorized by The Marlin Firearms Company or use of non-Marlin parts are not covered by the warranty.

THIS WARRANTY GIVES YOU SPECIFIC LEGAL RIGHTS, AND YOU MAY ALSO HAVE OTHER RIGHTS WHICH VARY FROM STATE TO STATE.

### MARLIN'S PERFORMANCE UNDER THE ABOVE WARRANTY

1. After notice of defect in material and/or workmanship is received by The Marlin Firearms Company, Marlin shall send instructions for shipment of the firearm; and repairs will be made and the firearm returned within a reasonable time after the firearm is received. Cost of shipping, insurance charges, etc. involved in returning the firearm to the company shall be prepaid by the original owner.
2. Cost of parts and labor performed shall be provided without charge by The Marlin Firearms Company.
3. If The Marlin Firearms Company, after receipt of the firearm, determines that the defects in material and/or workmanship were the result of abuse and/or neglect, or otherwise not covered by the warranty set forth above, Marlin shall notify such owner to that effect and give an estimate for repair. In such cases, repair, return shipping and insurance charges, etc. shall be paid by such owner.
4. In the event that The Marlin Firearms Company is unable to make warranty repairs to the firearm, it shall, within a reasonable time after its receipt, notify the owner to that effect and give him the option either to receive a replacement of the same model, if then available in its inventory, or to receive a refund, either of which, if feasible, will be made through the store of purchase.

**The Marlin Firearms Company**  
100 Kenna Drive, North Haven, CT 06473-0905  
[www.marlinfirearms.com](http://www.marlinfirearms.com)

## **Before You Use This Firearm**

It is very important that you read and understand this manual before using your new rifle. Warnings should be read and heeded carefully. Also follow the safety rules listed in "Marlin's Guide to Gun Safety", printed in this manual.

• **WARNING:** Marlin firearms are designed and manufactured to handle standard factory-loaded ammunition which conforms to SAAMI (Sporting Arms and Ammunition Manufacturers' Institute Inc.) standards with dependability and safety. Due to the many bullet and load options available, the element of judgement involved, the skill required, and the fact that serious injuries have resulted from dangerous handloads, Marlin does not make any recommendations with regard to handloaded ammunition.

## **Use of the Offset Hammer Spur**

A detachable offset hammer spur, fixed to the hammer, must be used when using a scope. An offset hammer spur and wrench were packed with your gun (in the envelope containing the adapter base). For safe operation when using a scope, the offset hammer spur must be installed. Installation instructions are printed on the envelope, as

well as below. **We recommend that you remove the offset hammer spur when not using a scope.**

For right hand use, position the offset hammer spur so that it protrudes from the right side of the hammer, slide the offset hammer spur as far forward on the hammer as it will go, and tighten set screw. For left hand use, mount the offset hammer spur so that it protrudes from the left side of the hammer, and tighten set screw. Be sure the set screw tightens into the small notch on either the right or left side of the hammer, and check regularly to be sure that it is tight.

## **Safety Features**

• **WARNING:** Your rifle is equipped with two safety devices, which, when used properly, provide an added degree of safety. Before loading your rifle, become familiar with the operation of the hammer block safety and the two hammer positions (FULL COCK and REBOUND/SAFETY), by practicing with the rifle unloaded.

• **WARNING:** Never disassemble the safety. It has been correctly designed, fitted and tested, and is not reversible. Any mechanical device can fail, however, so never rely on the safety to justify careless handling. Never use a firearm with a safety that does not function properly.

## **1. How to Operate the Hammer Block Safety**

The hammer block safety mechanism is a round button located at the rear of the receiver. To put your rifle on SAFE, push the safety button from left to right as far as it will go (See A). The safety is now on SAFE and the word SAFE will appear around the right side of the button.

The safest way to carry your rifle when it is loaded, is with the hammer in the Rebound/Safety position, and the safety on SAFE. At all other times the action should be open.

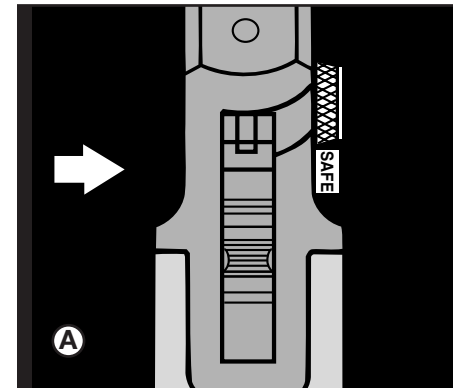

SAFE Position

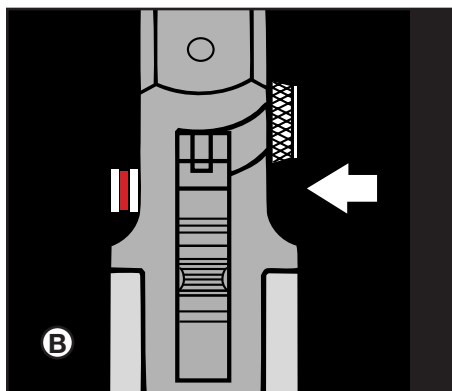

*FIRE Position*

To move the safety button to the FIRE position, push it from right to left as far as it will go (See B). A red ring will appear around the left side of the button as a warning that it is in the FIRE position. If the hammer is pulled all the way back to full cock, the rifle will be cocked and ready to fire.

## 2. Hammer Positions

**A.** The Full Cock position of the hammer is when it is at its furthest point from the firing pin (See C). If the trigger is pulled when the hammer is in this position, and the safety button is in the FIRE position, the gun will fire.

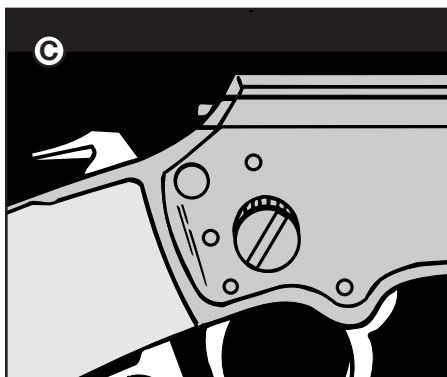

*Full Cock*

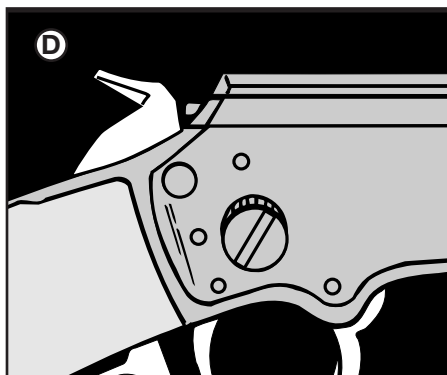

*Rebound/Safety*

**B.** Your new rifle has a feature known as a “rebounding hammer”. Each time the trigger is pulled (with the safety in the FIRE position) the hammer strikes the firing pin, and then automatically “rebounds” to the Rebound/Safety position (See D).

**3. To move the hammer to the Rebound/Safety position from the Full Cock position,** first put the hammer block safety button on SAFE. The hammer may be moved from Full Cock to the Rebound/Safety position by firmly holding the hammer in the Full Cock position with your thumb. Keep your thumb on the hammer as you pull the trigger. As soon as you feel the hammer exerting forward pressure against your thumb, remove your finger from the trigger and ease the hammer slowly forward to the Rebound/Safety position (See E & F). To resume the Full Cock position, pull the hammer all the way to the rear.

•**WARNING:** When the hammer is in the Rebound/Safety position and the hammer block safety is in the FIRE position, if the trigger is held back and the hammer is struck, the rifle may fire.

Changing hammer position—

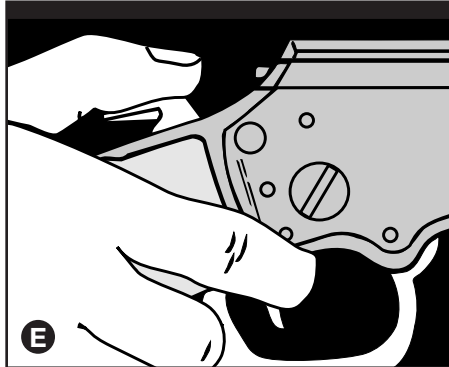

Full Cock to

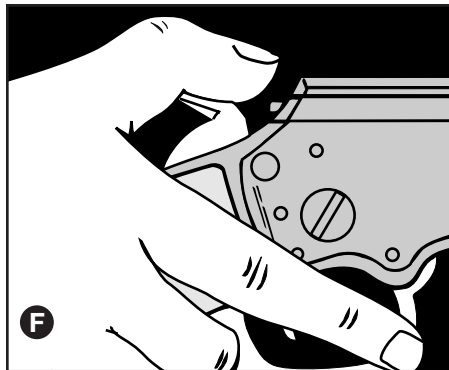

Rebound/Safety

## How to Load

- **WARNING:** Never attempt to load your rifle with ammunition that does not meet the cartridge designation stamped on the barrel. Use only clean, dry, factory-loaded ammunition which conforms to industry standards.
- **WARNING:** Before loading or firing, always check the bore and chamber to be sure they are free of grease, oil, or any other obstruction. With the action open, and the hammer block safety button on SAFE, look through the barrel to see if there is an obstruction. If there is, it must be removed before firing. Otherwise, personal injury or damage could result.
- **WARNING:** This rifle will not function properly unless the inner magazine tube is locked securely in place.
- **WARNING:** Never add cartridges to a partially loaded tubular magazine.
- **WARNING:** The following procedure is the only recommended method of loading.

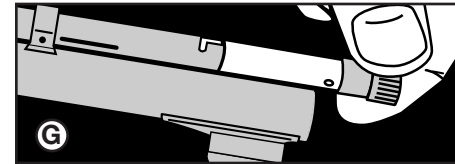

Unlocking the magazine

### Loading the Magazine

Be sure the bolt is closed (lever closed), the hammer is in the Rebound/Safety position, the hammer block safety is on SAFE and the rifle is pointed in a safe direction. Turn your rifle upside down and unlock the inner magazine tube by pushing in and turning the knurled locking end knob (See G). Keeping your fingers away from the muzzle, pull the inner tube from the outer tube until the loading port is exposed.

With the muzzle raised slightly, drop cartridges into the loading port, bullet end toward the muzzle (See H). When you have loaded up to the magazine capacity (26 Shorts, 21 Longs or 19 Long Rifles), slide the tube back in place, turning it slightly to ease passage over the loaded rounds. **DO NOT FORCE THE TUBE DOWN.** Then rotate the knurled locking end knob to the locked position. The inner tube will not lock in place if the number of cartridges loaded exceeds the magazine capacity.

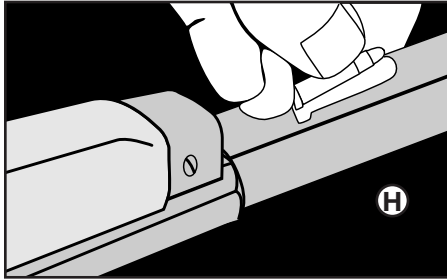

*Loading the magazine*

Marlin lever action 22 rifles are NOT designed for single loading. Always load cartridges through the tubular magazine as directed above.

#### Preparing to Fire

With the rifle pointed in a safe direction, completely open and close the lever one time, and put the hammer block safety in the FIRE position. Your rifle is loaded, cocked, and ready to fire.

•**WARNING:** If you do not want to fire at this point, put the hammer block safety on SAFE, then return the hammer to the Rebound/Safety position. (See D).

#### How to Fire

With the hammer in the Full Cock position, and the safety in the FIRE position, and the rifle pointed at the target, squeeze the trigger. Work the lever fully open and closed for each repeat shot. Failure to fully operate the lever can result in a jammed action. If you do not fire all the cartridges in the magazine, be sure to put the hammer block safety on SAFE, and the hammer in the Rebound/Safety position until you are ready to fire again.

#### What to do if Rifle Fails to Fire

##### Misfire

If you have squeezed the trigger and the cartridge does not fire, remain in the shooting position, pointing the gun in a safe direction. Count to 10, then unload the rifle completely. (See “How to Unload”).

##### Underpowered Shot

A “squib”, or underpowered shot, should not occur if the ammunition is clean, dry, and factory loaded. You can normally tell if a shot is underpowered by the unusually low sound it makes.

•**WARNING:** Because the bullet may actually still be in the barrel, you must unload completely and, with the action open, use a cleaning rod to see if there is an obstruction. If there is, it should be removed by a qualified gunsmith. Otherwise, personal injury or damage could result.

#### How to Unload

**Note:** The inner magazine tube must be locked in place to unload the rifle.

Keeping your fingers away from the trigger, with the hammer block safety on SAFE, and with the rifle pointed in a safe direction, manually eject all cartridges by opening and closing the lever, until you are sure the chamber and magazine are empty (See I). The lever must be completely closed and then fully opened to insure proper feeding and ejection of all cartridges. Then, with the lever in the open position (bolt to the rear), inspect the



*Unloading through the action*

chamber, carrier and magazine carefully to be sure there are no cartridges left. Then check the magazine inspection port on the left side of the receiver (See J). If the magazine is empty, the red follower will be visible through this hole. If you do not see the red follower, repeat the above steps until you do.

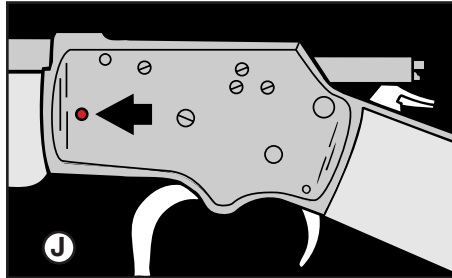

Magazine inspection port

•**WARNING:** Remember, always keep the muzzle pointed in a safe direction, because until a visual check has been made, you must assume that a live round remains in the chamber, and/or magazine.

## Sighting

Your rifle has been sighted-in and test-fired at the factory. Due to individual shooting characteristics, however, sighting should be range verified.

## Vertical Correction (Elevation)

To raise the point of impact, raise the rear sight, by moving the sight elevator rearward. To lower the point of impact, lower the rear sight, by moving the sight elevator forward.

## Horizontal Correction (Windage)

To move the point of impact to the left, tap the rear sight base to the left. To move the point of impact to the right, tap the rear sight base to the right.

## Scope Mounting

Your rifle is drilled and tapped for scope mounts. They are made by Tasco, Weaver, and others, and are available through your local gun dealer. You may also order directly from Marlin Gun Service. Call 1-800-544-8892 for more information.

## How to Clean Your Rifle

•**WARNING:** Never attempt to wipe down or clean a loaded firearm. Follow the instructions under "How to Unload", before cleaning.

**To clean the bore from the breech end, follow this procedure.**

With the lever closed, the safety on SAFE, and the hammer in the Rebound/Safety

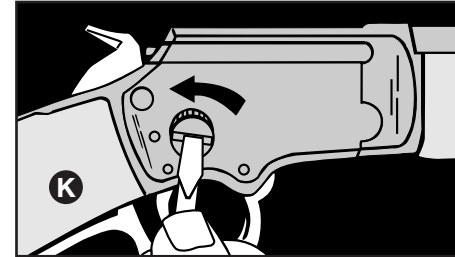

Loosening takedown screw

position, loosen the takedown screw until it is floppy in the receiver (do not try to remove it completely) (See K). Place a folded cloth on the floor or a work bench. Hold the butt section of the rifle firmly and let the left side of the muzzle strike the cloth (See L). Do not touch the lever. You may have to repeat this tapping several times before the two parts of the receiver separate. You can then remove the breech bolt by sliding it to the rear as far as it will go, and lifting it out (See M). This completes the takedown operation.

To prevent damage to the ejector while cleaning, hold it down as far as it will go with a small screwdriver (See N), and at the same time insert a second screwdriver into the slotted rivet just ahead of the ejector (See O). Then turn the rivet slight-

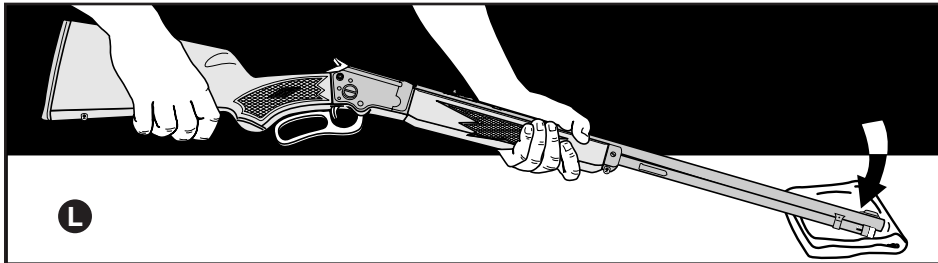

*Tapping muzzle to separate two-piece receiver*

ly until the ejector is locked in position. (Failure to lock the ejector down may result in damage to it while cleaning the bore from the breech end.)

The action and bore may be cleaned and oiled while the gun is in this state of disassembly.

**Caution:** Before using any solvent or other gun cleaning product, read the label carefully to be sure it will not damage either the finish, or any parts of this firearm.

To clean the bore and barrel, use any standard 22 caliber commercial cleaning rod and cleaning patches. Clean the barrel with powder solvent and wipe lightly with gun oil after cleaning.

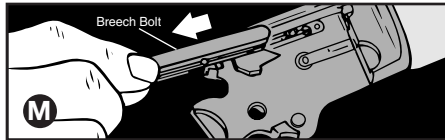

*Removing breech bolt*

Use a very thin coat of light oil during below freezing conditions. A dry graphite used sparingly is recommended for cold weather lubrication. Condensation droplets will form soon after the rifle is brought into a warm room, or the rifle may become wet during inclement weather. In an case, all moisture should be removed. Exterior metal finishes may be wiped down with a slightly oiled cloth.

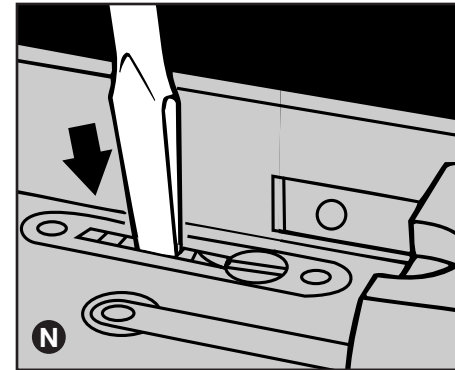

*Pushing ejector down*

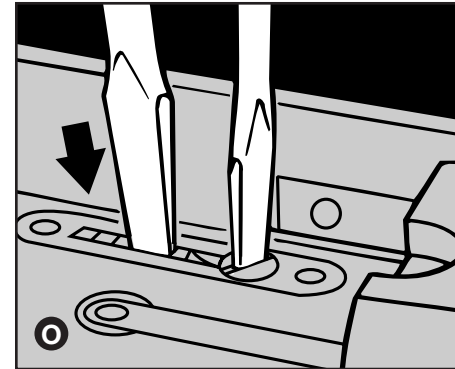

*Turning rivet to lock ejector down*



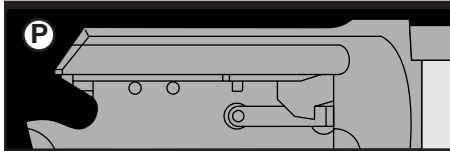

*Breech bolt forward for reassembly*

**To reassemble, reverse the takedown process described above.**

Be sure to release the ejector by turning the ejector locking rivet so that the ejector springs back to its original operating position (See O). Be sure the breech bolt is as far forward as it will go. (See P). Do not touch the lever during reassembly. Be certain that the two receiver parts are completely mated, so that both sides are smooth and flat (See Q & R). Tighten takedown screw.

For long term storage, *lightly* oil the bore, barrel and action with gun oil. Your rifle should be completely unloaded and stored in a dry, ventilated area. Do not store in a gun case.

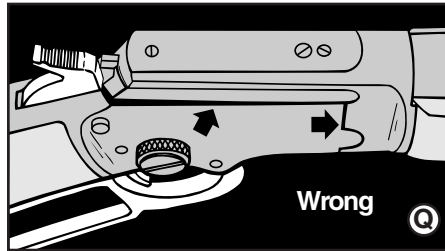

*Receiver parts not fully mated.*

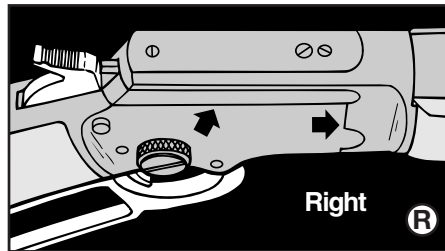

*Receiver parts properly mated.*

## **Repair Instructions**

Your firearm has been designed, engineered and manufactured in accordance with Marlin's rigid quality control standards. However, any mechanical device may occasionally require adjustment or repair.

Questions regarding the performance and serviceability of your firearm should be addressed to Marlin Gun Service. You should include the serial number, model number and a full description of the conditions and problems involved.

## **Warranty Repairs**

Our warranty policy covers all our firearms against defects in workmanship or material for a period of five years from the date of purchase to the original owner. See the inside front cover of this manual for warranty details.

Guns requiring warranty repair should be returned to the factory. Be sure to follow the "Shipping and Handling" instructions on this page.

## **Non-Warranty Repair**

A competent gunsmith may be able to repair your gun. If not, ship it to the factory, following the "Shipping and Handling" instructions on this page.

After receiving your firearm, we will send you an estimate of the repair cost. Repairs will begin upon receipt of your check or money order. If repairs are not possible, your firearm will be returned.

## **Shipping and Handling**

When sending your firearm to the factory, please follow these instructions:

1. Prior to shipping, be absolutely certain that the firearm is completely unloaded (See "How to Unload").
2. Pack your firearm carefully. Use ample cushioning material and a sturdy outer cardboard box. Do not ship in a special container which you want returned.

3. Accessories such as scopes, scope mounts, gun case, quick-detach type swivels, slings, etc. should be removed prior to returning the firearm.
4. Inside the box, include the following information: model number, serial number, description of damage or problem, and under what conditions problem occurs.
5. ***Keep a record of your serial number when returning a firearm.***
6. Clearly mark your return address on the outside of the box and on your instruction sheet.
7. Do not ship live ammunition under any circumstances.
8. Ship your firearm via insured Parcel Post or U.P.S. Shipment must be prepaid and addressed to:

**MFC INC.  
ATTN: SERVICE DEPT.  
100 KENNA DRIVE  
NORTH HAVEN, CONN. 06473**

## **IMPORTANT**

If you have any questions or problems relating to your new Marlin, would like additional information on safe operation, or wish to order parts or accessories, just call our Customer Service Center. A Service Representative can be reached at the number listed below, between 8 A.M. and 4:30 P.M. (Eastern Time), Monday through Friday.

**1-800-544-8892**  
**(Toll Free)**

Please record the firearm serial number, date of purchase and where purchased below.

Serial #: \_\_\_\_\_

Date of Purchase: \_\_\_\_\_

Purchased From: \_\_\_\_\_

**In case of loss or theft, supply this information to the proper authorities.**

# The Fascinating History of Marlin

**W**ritten by the late William S. Brophy, Marlin's Senior Technical Manager and Official Company Historian for many years, this prodigious book details the history of the Marlin Firearms Co. and its products. The hardbound volume contains more than 600 pages and over 1000 illustrations. Must reading for anyone interested in all the models — pistols, rifles and shotguns — made by Marlin, and in the story of more than a century of firearms production in America.

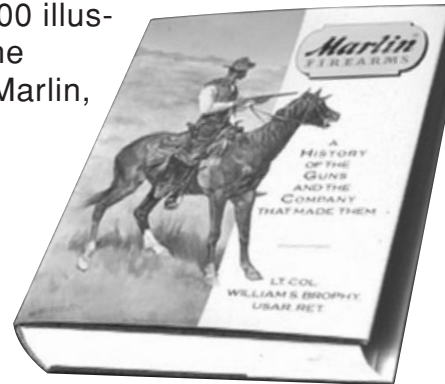

For more information, write:

**Marlin Firearms Co.**  
**Department OM**  
**100 Kenna Drive**  
**North Haven, CT 06473**

## Marlin's Guide to Gun Safety

1. Read and understand the owner's manual before using a firearm.
2. If you are unfamiliar with firearms, attend a firearms safety class taught by a certified instructor.
3. Handle every firearm as if it were loaded and ready to fire.
4. Control the muzzle, and never point a firearm at anything you don't want to shoot.
5. Keep the safety on SAFE until you are ready to shoot.
6. Unless you are hunting, carry your firearm empty, with the action open.
7. Before shooting, be sure you have an adequate backstop. All ammunition is dangerous beyond your line of sight.
8. Avoid ricochets by never shooting at water or any hard, flat surface.
9. Do not run, climb, or jump over an obstacle with a loaded firearm.
10. Do not climb into or out of a tree or tree stand with a loaded firearm.  
Do not allow others to pass loaded firearms to you while in a tree stand.
11. Do not enter or ride in a motor vehicle with loaded firearms.
12. Do not lean a loaded firearm against anything.
13. Do not bump, drop or jar a loaded firearm.
14. Do not pull a firearm toward you by the muzzle.
15. Wear hearing protectors when shooting.
16. Wear impact-protective glasses when shooting, disassembling or cleaning firearms.
17. Avoid alcoholic beverages and drugs before and during shooting.
18. Use only ammunition of the correct gauge, caliber, size and bullet shape for your firearm.
19. Do not use damaged, dirty, modified, or improperly handloaded ammunition.
20. Keep the barrel and mechanism of the firearm free of obstructions.
21. Do not use a firearm that fails to function properly. Do not try to force a jammed action.
22. Be sure no one is in the path of ejecting shells or cartridges.
23. Do not interchange parts between firearms, and be sure disassembly and reassembly are correct and complete.
24. Before cleaning, be sure the chamber, action and magazine are completely unloaded.
25. Unload firearms before storing, transporting, or leaving unattended.
26. Store firearms and ammunition separately, locked and out of the reach of children.

**Failure to follow these rules, or other instructions in this manual, can result in personal injury.**

Printed in U.S.A.

### **WARNING**

**Children are attracted to and can operate firearms that can cause severe injuries or death.**

**Prevent child access by always keeping guns locked away and unloaded when not in use. If you keep a loaded firearm where a child obtains and improperly uses it, you may be fined or sent to prison.**

### **ADVERTENCIA**

**A los niños los atraen las armas de fuego y las pueden hacer funcionar. Ellos pueden causarse lesiones graves y la muerte.**

**Evite que los niños tengan acceso a las armas de fuego guardándolas siempre con llave y descargadas cuando no las esté utilizando. Si usted tiene un arma de fuego cargada en un lugar en que un niño tiene acceso a ella y la usa indebidamente, le pueden dar una multa o enviarlo a la cárcel.**

**Health Warning:** Discharging of firearms in poorly ventilated areas and handling ammunition may cause exposure to lead and/or lead compounds. Exposure may cause cancer, birth defects or damage to the kidney, nervous, blood forming and reproductive systems. Have adequate ventilation at all times, especially in confined areas. Wash hands thoroughly after shooting, handling ammunition, or cleaning a firearm. Do not eat or smoke during these activities.

**Safety Warning:** Marlin strongly recommends that you take a hunter safety course, taught by a certified instructor, before you use this firearm. Your State Fish & Game Dept. or a local gun shop can suggest courses in your area.

**Safety Warning:** Keep this firearm out of the reach of children, unauthorized individuals, and others unfamiliar with the safe handling of firearms.

12/03 402000

# Marlin®

## LEVER ACTION 22 RIFLES

(Shorts, Longs,  
Long Rifles)

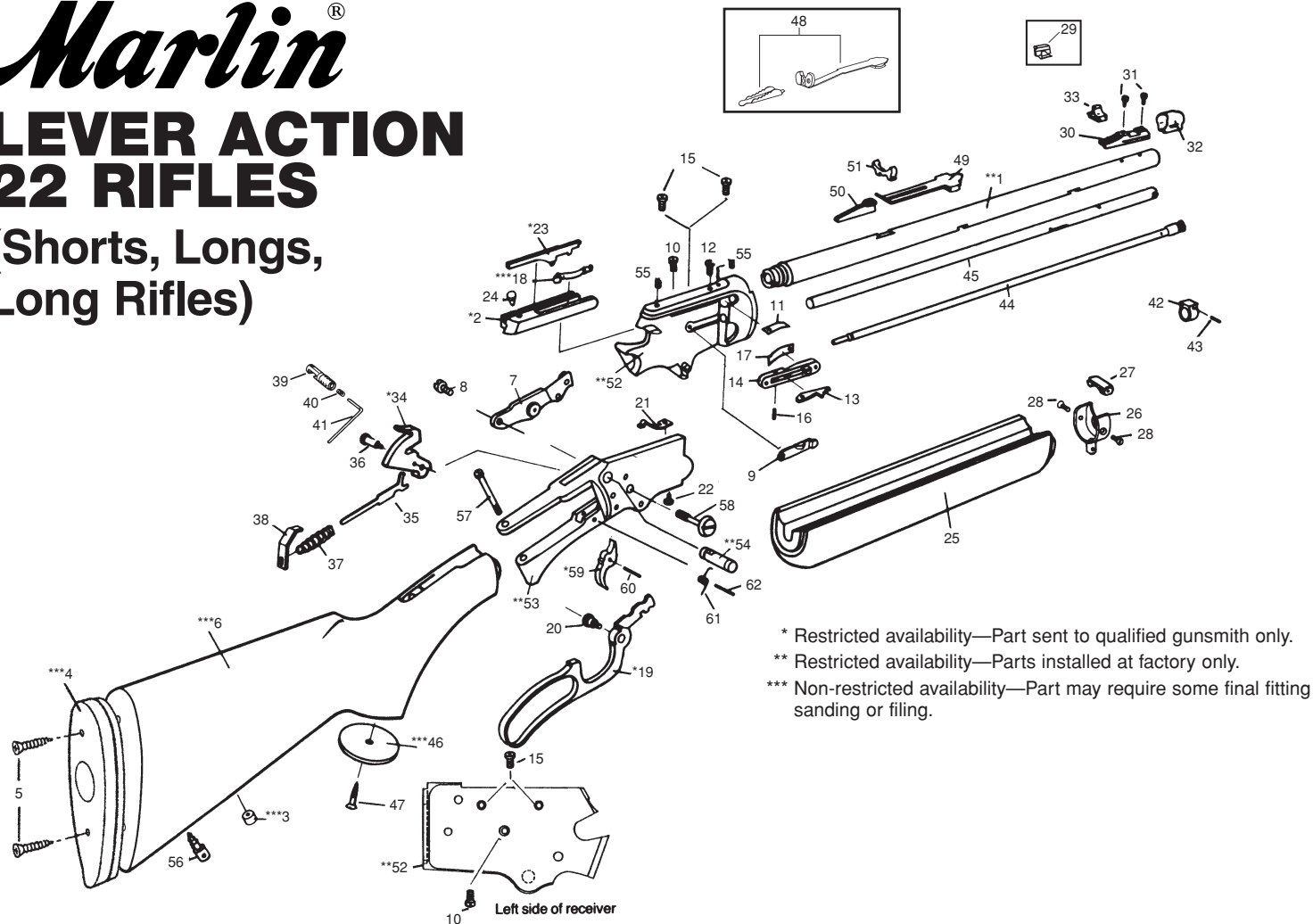

\* Restricted availability—Part sent to qualified gunsmith only.  
 \*\* Restricted availability—Parts installed at factory only.  
 \*\*\* Non-restricted availability—Part may require some final fitting sanding or filing.

### PARTS LIST LEVER ACTION 22 RIFLES

For parts prices, call 1-800-544-8892 (8 A.M. to 4:30 P.M., Eastern Time, Weekdays)  
 Be sure to mention gun serial number when ordering parts

ILL. NO.	PART NAME	ILL. NO.	PART NAME	ILL. NO.	PART NAME
**1	Barrel	*23	Firing Pin	45	Magazine Tube Outside
*2	Breech Bolt	24	Firing Pin Retaining Stud	***46	Pistol Grip Cap
***3	Bullseye	25	Forearm	47	Pistol Grip Cap Screw
***4	Buttpad	26	Forearm Tip	48	Rear Sight Complete
5	Buttpad Screw (2)	27	Forearm Tip Tenon	49	Rear Sight Base
***6	Buttstock	28	Forearm Tip Tenon Screw (2)	50	Rear Sight Elevator
7	Carrier Assembly	29	Front Sight Complete	51	Rear Sight Folding Leaf
8	Carrier Screw	30	Front Sight Ramp Base	**52	Receiver (Left Side)
9	Cartridge Cutoff	31	Front Sight Ramp Base Screw (2)	**53	Receiver (Right Side)
10	Cartridge Cutoff Screw	32	Front Sight Ramp Hood	**54	Safety Assembly
11	Cartridge Guide Spring	33	Front Sight Ramp Insert		Scope Adapter Base w/Screws (Not Shown)
12	Cartridge Guide Spring Screw	*34	Hammer		Scope Adapter Base Screw (2) (Not Shown)
	Ejector Base Assembly, Consisting of:	35	Hammer Rebound Strut	55	Scope Mount Dummy Screw (2)
13	.Ejector	36	Hammer Screw	56	Swivel Stud, Rear
14	.Ejector Base w/Rivet	37	Hammer Spring (Mainspring)	57	Tang Screw
15	.Ejector Base Screw (2)	38	Hammer Spring Adjusting Plate	58	Thumb Screw
16	.Ejector Pin	39	Hammer Spur Assembly (Includes Parts 40 & 41)	**59	Trigger
17	.Ejector Spring	40	Hammer Spur	60	Trigger Pin
***18	Extractor	41	Hammer Spur Wrench	61	Trigger Spring
*19	Finger Lever	42	Magazine Tube Band	62	Trigger Spring Pin
20	Finger Lever Screw	43	Magazine Tube Band Pin		
21	Finger Lever Spring	44	Magazine Tube Assembly		
22	Finger Lever Spring Screw				

<b>ILL. NO.</b>	<b>PART NAME</b>	<b>39A Part No.</b>
**1	Barrel	102020
*2	Breech Bolt	102386
***3	Bullseye	320101
***4	Buttpad	417002
5	Buttpad Screw (2)	420590
***6	Buttstock	502214
7	Carrier Assembly	502861
8	Carrier Screw	302492
9	Cartridge Cutoff	302189
10	Cartridge Cutoff Screw	302090
11	Cartridge Guide Spring	302294
12	Cartridge Guide Spring Screw	302290
	Ejector Base Assembly, Consisting of:	502068
13	Ejector	102068
14	Ejector Base w/Rivet	502167
15	Ejector Base Screw (2)	302091
16	Ejector Pin	302098
17	Ejector Spring	402095
***18	Extractor	202069
*19	Finger Lever	102470
20	Finger Lever Screw	302192
21	Finger Lever Spring	402196
22	Finger Lever Spring Screw	302193
*23	Firing Pin	202299
24	Firing Pin Retaining Stud	302152
25	Forearm	102017
26	Forearm Tip	502728
27	Forearm Tip Tenon	220429
28	Forearm Tip Tenon Screw (2)	320191
29	Front Sight Complete	N/A
30	Front Sight Ramp Base	221139
31	Front Sight Ramp Base Screw (2)	320991
32	Front Sight Ramp Hood	320245
33	Front Sight Ramp Insert	230744
*34	Hammer	102273
35	Hammer Rebound Strut	302274
36	Hammer Screw	302190
37	Hammer Spring (Mainspring)	420294
38	Hammer Spring Adjusting Plate	320175
39	Hammer Spur Assembly (Includes Parts 40 & 41)	502377
40	Hammer Spur Screw	420193
41	Hammer Spur Wrench	420204
42	Magazine Tube Band	220121
43	Magazine Tube Band Pin	420698
44	Magazine Tube Assembly	502522
45	Magazine Tube Outside	302223
***46	Pistol Grip Cap	320808
47	Pistol Grip Cap Screw	420290
48	Rear Sight Complete	502242
49	Rear Sight Base	520241
50	Rear Sight Elevator	320242
51	Rear Sight Folding Leaf	202242
**52	Receiver (Left Side)	102160
**53	Receiver (Right Side)	102261
**54	Safety Assembly	202183
	Scope Adapter Base w/Screws (Not Shown)	202231
	Scope Adapter Base Screw (2) (Not Shown)	302093
55	Scope Mount Dummy Screw (2)	320493
56	Swivel Stud, Rear	420793
57	Tang Screw	320391
58	Thumb Screw	302292
59	Trigger	102243
60	Trigger Pin	402097
61	Trigger Spring	402094
62	Trigger Spring Pin	420397